

Sungale

MODEL: ID801WT

Cyberus

--the smart info engine
User manual



User Notice

This product has met electronic emissions standards required. It can be used safely at home.



Contents

Before operation

Product introduction	2
Product specification	3
Safety precautions	4
Parts and components	6
Navigation controls	7
Memory cards connection	8
PC connection and ASSP tool	9

Getting started

Getting started	10
-----------------	----

Basic functions

eReader/Photo/Music/Video	11
Documents/Clock/Note Pad/Setting	13

Advanced functions

Network	16
Net Dict/Weather/IP radio/News	18
Gmail/Route/Picasa/Stock/Fastflip	21

Screen calibration

Screen calibration	24
--------------------	----

Customer management

Question and answer	25
FCC and safety information	26

Before Operation

Product introduction

Sungale Cyberus is a smart information engine which will offer you great convenience to play multi-media files and surf on line with wireles networking capability.

Its powerful multi-function makes it your indispensable assistant in your daily life. You can:

show your favorite digital pictures, play audios and videos, read eBook, look for words from the internal dictionary. Inquire local weather condition by inputting zip code or city's name, listen to thousands of IP radio all around the world, review pictures in your Picasa account. read Google and Yahoo news, receive G-mails, look over stock information, guiding traffic, make a note for the important issues, set up date and time as well as alarm. Its main menu's picture is as follow:

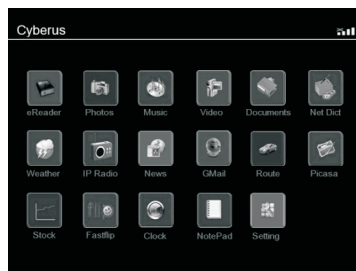

Tips: You should firstly set up network before enjoy these functions: Net Dict, Weather, IP Radio, News, Gmail, Route, Picasa, Stock, Fastflip. Please refer to the content of Network.

Before Operation

Product specification

Audio file formats: wma, ogg, aac

Video file formats: avi, mjpeg, divx, xvid, dat, wmv, 3gp, flv, mpg

Picture file formats: JPG, TIF, PNG, BMP, GIF(Static picture)

E-book file formats: PDF, txt, html, epub, fb2, rtf, ztxt, chm, plucker, palmdoc, tcr, oeb, openreader, non-DRM'ed mobipocket

Memory cards support: SD/MMC

USB Connection: USB device

Brightness: 500:1

Contrast: 250cd/m2

Power: AC Adapter Input 110-240V, DC 5V

Compatible PC system: Windows 2000/XP/Vista/7, Macintosh computer (MAC)

Environmental operating ranges

Operation: 32~95F, Humidity 0~85%

Storage:-4~140F, Humidity 10~90%

Customer support home page

The latest support information is available at the following home page address:

[Http://www.sungalewifi.com](http://www.sungalewifi.com)

Take a moment now to visit the web site!

You may receive product updates and other valuable information from the service supplier that can improve your experience with our product.

Note: It is recommended that this Cyberus is to be operated with your home wireless router or office wireless router. For complex office wireless surrounding, please ask your web manager to give assistance to link to the internet.

All data are provided for reference purposes only. Sungale reserves the right to make any changes without prior notice.

Before Operation

Safety precautions

Electric safety

Make sure to review the following guidelines to ensure user safety and avoid product failure.

Power Precautions

⚠ WARNING: indicates information that, if neglected, could result in serious injury and/or death to the user.

⚠ CAUTION: indicates information that, if neglected, could result injury to the user and/or material damage.

01. Use only the authorized power supply product. Failure to do so could result in product malfunction.



02. When connecting the power source, make sure that your hands are free of moisture. Failure to do so could result in electrical shock.



03. Make sure that the power supply is firmly plugged in and not loose. Failure to do so could result in electrical shock.

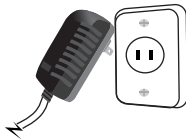

04. Do not let the power cord get overly entangled and do not place any heavy objects on the cord. Failure to do so could result in electrical shock.

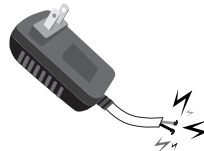

05. Do not connect the power supply to an electrical power strip with other various connections. Failure to do so could result in fire.

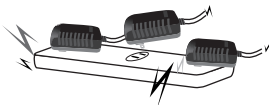

06. Disconnect the power supply during inclement weather conditions that include thunder and lightning. Failure to do so could result in fire.



Before Operation

Safety precautions

Make sure to review the following guidelines to ensure user safety and avoid product failure.

Product Related

01. Dropping the product or subjecting it to a significant impact can cause critical damage.

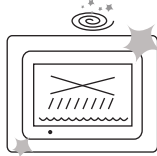

02. Spilling water or any other liquid on the product can cause critical damage.



03. Striking or scratching the LCD screen may cause critical damage.

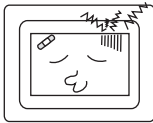

04. When cleaning the LCD screen, turn off the power and wipe it gently with a soft cloth.

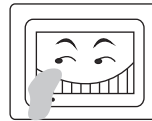

05. Do not subject the product to severe humidity and/or heat.

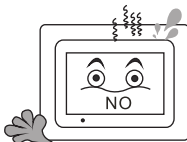

06. Make sure to power off the unit before disconnecting the power supply.

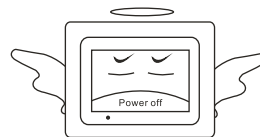

Before Operation

Parts and components

As Sungale is constantly working to improve its products' performance, these components may be modified without notice.

The components may differ slightly in appearance with the images provided.

Basic Components

These components are included with your product.

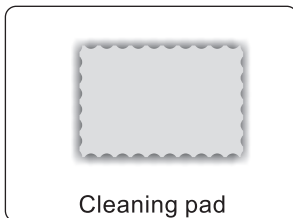
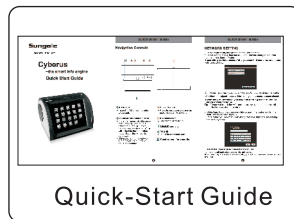
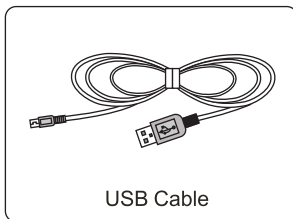
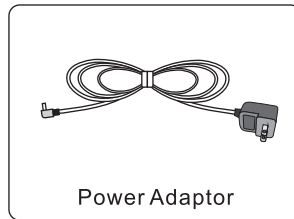
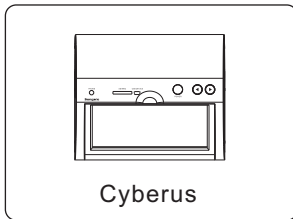

Before Operation

Navigation controls

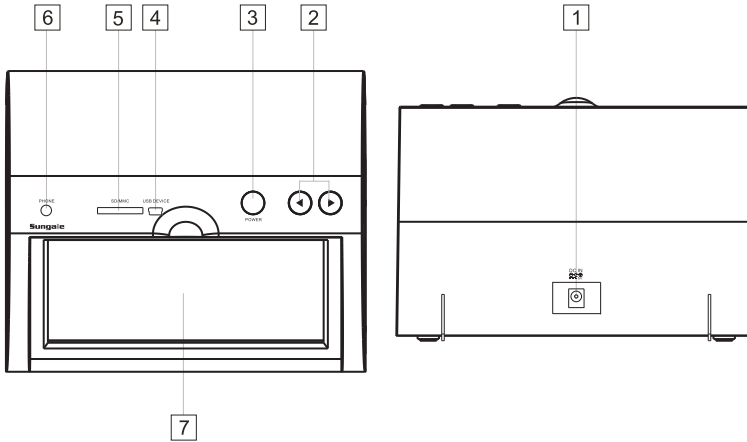

1 DC IN slot

- Insert the DC power adaptor to the unit.

2 Calibration/Volume button

- In the main menu, double press the button “◀”, and double press the button “▶”, then double press the button “◀”, it will enter into the calibration mode. Touch the “+” icon to calibrate.
- When displaying the video or audio, press the buttons to adjust the volume.

3 Power Switch

- Press to the button to power on, and press again to power off.

4 USB connector

- Connect the unit to the PC.

5 SD/MMC card slot.

6 PHONE

- Insert for earphone use.

7 Touch screen for operation.

Before Operation

Memory cards connection

Loading files (movie/ music/ photo/ ebook)

1. Put the files to the SD/MMC cards or to your computer.
2. Insert the card to the unit if there are files in the card, and the unit can read the files in the card directly.

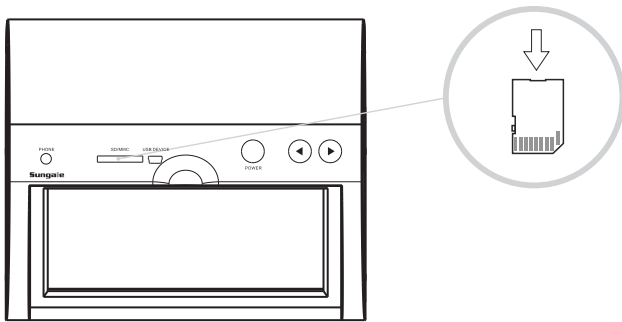

3. If the files in the computer, use the USB cable to connect the unit to the computer, copy and paste the files to the storage of unit. After the files transferring, please Safely Remove Hardware from the PC, and then directly unplug the USB connection, then find and enjoy the files in the storage of unit.

Before Operation

PC connection

Use the supplied USB cable to connect your Cyberus to your PC.

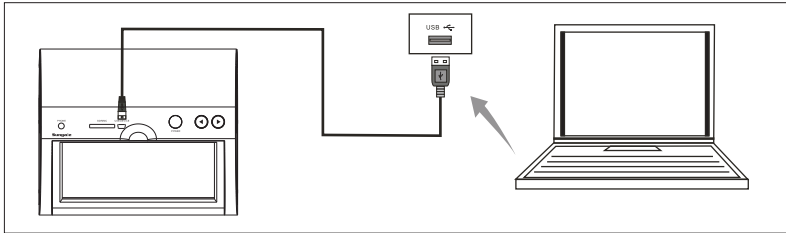

Note: The ASSP is a software in the internal memory developed by Sungale go manage the picture and audio files to optimize the utilization of the source of the memory. The ASSP is inapplicable to manage ebook and video files. Just use the unit as a regular storage device to manage ebook and video files after connecting the unit to the PC.

Tips: 1. If your PC has set as auto-run, you will enter into the ASSP interface directly, no operation needed.

2. The PC installed the anti-virus software or other hold-up software will make the "autorun.inf" invalid. In this situation, the file is set as hidden file. If you want to autorun the ASSP, you can set your PC to display hidden files.

3. When connecting PC with the Cyberus, you can only edit files by using the PC, the Cyberus will not function as in normal state.

Use ASSP

1. Click "Add File", your computer's files and folders will appear, double click the file or photo to add them to your Cyberus.

2. Hold on "Shift" or "Ctrl", you can download multi files or photos to your Cyberus. In this way, the photos downloaded will be stored at 800 x 600 pixels to suit your Cyberus screen and the MP3 files will be transferred into WMA file. When you have finished the operation, please safely remove the USB cable from your PC.

Tip: You also can take the Cyberus as a regular storage device, select the photos from your computer, and then paste them into internal memory of your Cyberus. In this way, the photos will be stored without compression. If you want to optimize your internal memory, you can select the photos, then click the "Convert".

Attention: You may find a series of files named "WMEncoder.exe", "FileConverter.exe", "encoder.exe", "Autorun.inf" and "gdiplus.dll" in the internal memory of the unit. It is the ASSP software, and not a virus. You can use it according to the instruction above.

Attention: Once you format the internal memory of your Cyberus, the ASSP software will be deleted.

In this situation, you can still use the Cyberus as a regular storage device, you can copy, paste and delete files after connecting your Cyberus to the PC. But there will be no ASSP tool to convert files anymore.

Getting started

Getting started

1. Power on the unit

Connect the AC adapter to wall outlet and the other side to the DC IN at the rear side of your Cyberus. Then your Cyberus will start booting. It will take a few seconds for booting. Then it enters into the main menu.

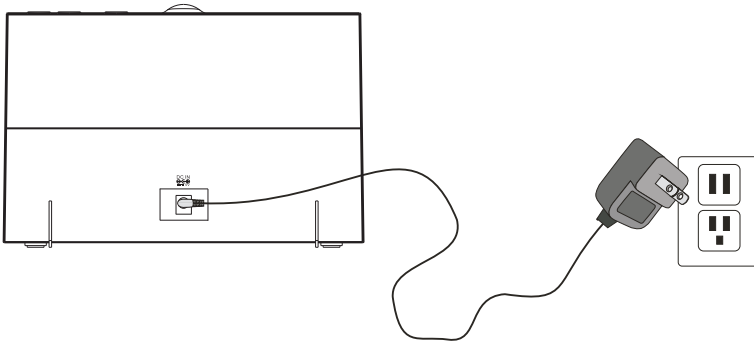

2. Using main functions

Touch the icons in the main menu to select the function you'd like to use. Make sure the machine has been connected to network before using the below functions, such as: Gmail, IP Radio, Net Dict, Weather, News, Stock, Fastflip, Route, Picasa.

Basic functions

eReader

In the main menu (home screen), touch “eReader”→touch internal memory or memory card→touch the eBook name to read. Touch  or “Exit” to exit.

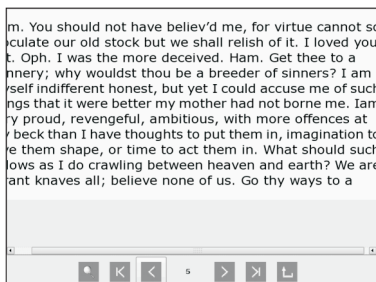
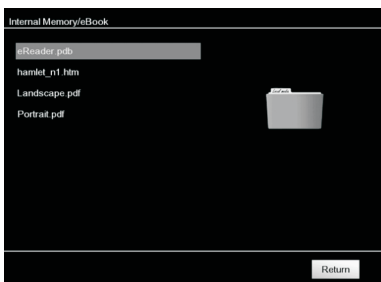







Photos

In the main menu, touch “Photo” icon→touch internal memory or memory card →touch the photo name, it will play the picture and several icons will be listed at the bottom of the screen.

There related functions are as follow:



-  :Add or close background music
-  :full screen slideshow
-  :last picture
-  :next picture
-  :rotate photos
-  :return

Touch “Exit” to exit.







Basic functions

Music

In the main menu, touch “Music” icon→touch internal memory or memory card→touch the song name, it will play the song and several icons will be listed at the bottom of the screen.

There related functions are as follow:



-  :show songs list
-  :Play
-  :Pause
-  :Last song
-  :Next song
-  :Return

Press ◀/▶ on the top of your cyberus machine to adjust volume.

Touch “Exit” to exit.

Video

In the main menu, touch “Video” icon→touch internal memory or memory card→touch the video name to play.

Touch the screen to exit to the video names list.

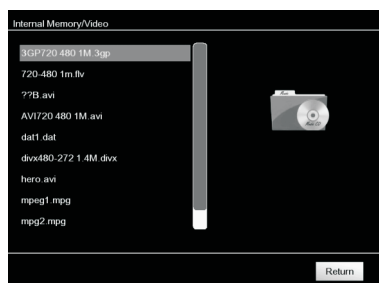

Press ◀/▶ on the top of your cyberus machine to adjust volume.

Touch Exit to exit.

Basic functions

Documents

In the main menu, touch "Documents" icon, touch "Internal memory" or your memory card name, you will enter into the interface with four categories: eBook, music, photos, video. Touch the category you want to enter related file list. Touch the file name to play.

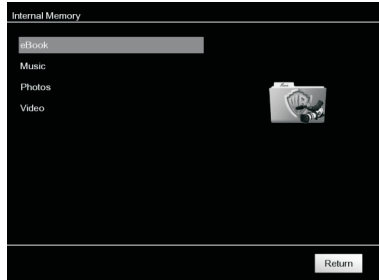

Touch "⏪" or "Exit" to exit.

Clock

In the main menu, touch "Clock" icon to enter the interface as follow:

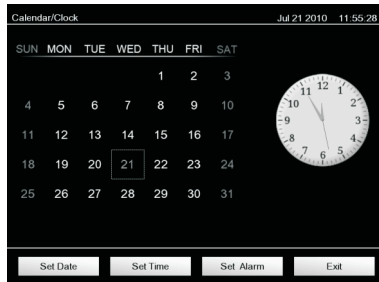

1. Touch "Set Date" to set up date and touch "Done" when finished.
2. Touch "Set Time" to set up time and touch "Done" when finished.
3. Touch "Set Alarm" to set up alarm clock time and touch "Done" when finished.
4. Press "Exit" to exit.
5. The alarm clock has 5 minutes snooze function.

Attn: Please make sure that the machine is working when the alarm time is up, or the machine won't work.

Basic functions

Note pad

In the main menu, touch "NotePad" icon and you will enter the interface as follow.

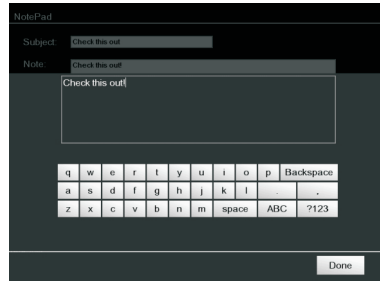
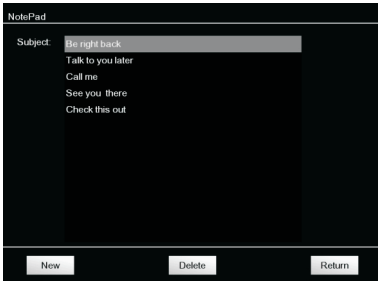

There are three icons at the bottom.

Touch "New" to add a note

Select a note and touch "Delete" to delete the note by using the on-screen keyboard. Please refer to page 17 about how to change input mode among lower-case letters and numbers as well as capital letters.

Touch "Exit" to exit

After adding a note, you will find the subject of your note listed on the screen. Touch the subject to check the note content and you will see the subject and note content.

Touch the note content to revise the content and touch "Done" icon at the right down corner and then the "Save" icon to save your revise.

When touching the note content, the cursor will appear in the content. Then you can revise the content. If the cursor doesn't appear, wait for a second and touch the screen again to have a try.

Basic functions

Setting

In the main menu, touch “Setting” icon. You will find the interface with three items: Network; Slideshow interval; Information.

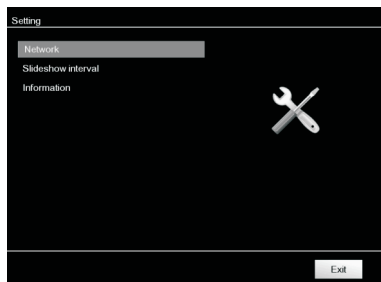

Slideshow interval

Touch slideshow interval to set up time interval during picture slideshow. You have 3 choices: 5 seconds, 10 seconds and 15 seconds. The selected time will be highlighted in yellow. Then touch Exit when finished.

Information

Touch information to find some technique information of your cyberus.

Advanced functions

Network

1. In the main menu, touch "Setting" icon and then "Network" icon, it will begin searching routers.

If searching routers successfully, you can find many routers' name in the router list.



 : Means it is an encrypted router. You need to input keys if use the router.

 : Shows the signal intensity. More orange lines mean strogner signal.

If searching router failed, you may find nothing in the router list. Just try to Search Again.

Tip: Please make sure that the Wi-Fi router is active, and do not take the unit too far away from the router.

Advanced functions

Network

2. Select and touch a router you'd like to use (The router you are familiar with or with more signal.)

If the router you selected is an encrypted one, input the keys using the soft keyboard.



Touch “?123” icon to change keyboard between numbers and lower-case letters. When the keyboard is in lower-case letters state, touch “ABC” icon to change the keyboard to show capital letters.

Touch the Done icon to connect to the router when finished inputting password.

3. The unit will auto start linking to network.

If connecting network successfully, touch the screen to go to the main menu and enjoy the functions including Net Dict; Weather; IP radio; News; Gmail; Route; Picasa; Stock; Fastflip.

If connecting network failed, there are some tips on the screen:

- Check your password, try again.
- It could be too many devices have been linked to your router, try later.
- Some wireless router can default DHCP closed, please open DHCP.
- Please check the signal strength, move your device closer to the router.

Advanced functions

Net Dict

You should firstly link to internet successfully before enjoy this function. please refer to the content in page 16 about network setting.

Online dictionary

After successful network link→go to main menu→touch “Net Dict” icon and an interface as follow will appear after a few seconds cache.

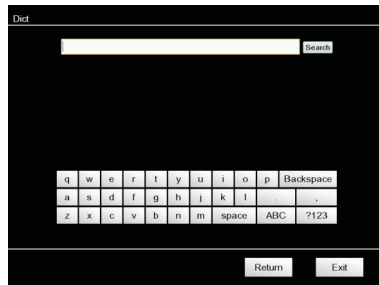

Input the word you would like to know by using the on-screen-keyboard and then touch “Search” icon, it will show the explanation interface of that word.

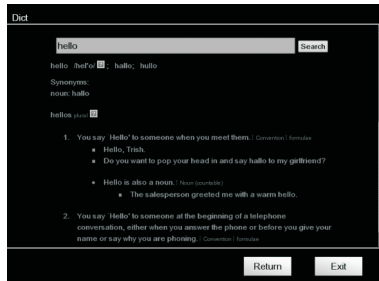

Touch “Return” to back to the dictionary.
Touch “Exit” to the main menu.

Advanced functions

Weather

You should firstly link to internet successfully before enjoy this function. please refer to the content in page 16 about network setting.

In the main menu, touch “Weather” icon to enter the interface as follow:

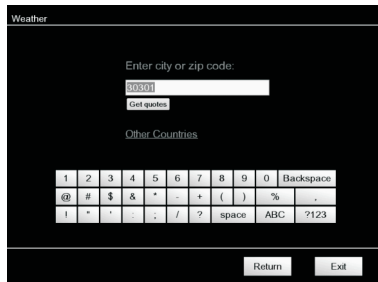

Input the city name or zip code of the city by using the on-screen-keyboard and then touch “Get quotes” to search weather report; or touch “Other countries” to find country names and related city name. Touch the city name and it will show the weather information.

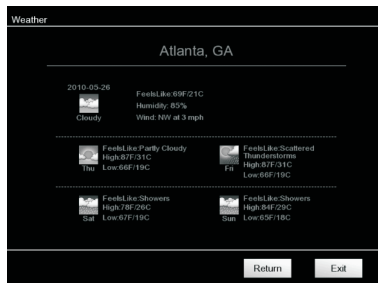

Touch “Return” to the last interface.
Touch “Exit” to the main menu.

Advanced functions

IP Radio

You should firstly link to internet successfully before enjoy this function. please refer to the content in page 16 about network setting.

In the main menu, touch "IP Radio" icon, it will enter the interface with IP radios of many sorts. Select one you want to play then it will show the different topics under the sort. Touch one of them, it will play after a few seconds cache.

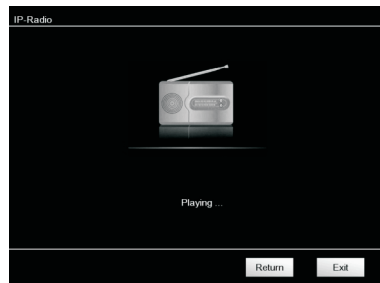

Press ◀ / ▶ on the top of your Cyberus machine to adjust volume.
Touch "Return" to the play list.
Touch "Exit" to the main menu.

News

You should firstly link to internet successfully before enjoy this function. please refer to the content in page 16 about network setting.

In the main menu, touch "News" icon, it will go to interface with two choices: Google and Yahoo
Touch one of them and the topics under it to show the related news content.
In the interface of showing news content, click on the links, if it has any, in each news story, you will see more detailed content under a browser, you can slip your fingers on the screen to move the content up/down/right/left to enjoy the content. After viewing the content, we would like to suggest you to tape on the "Return" on the screen to go back to the news assortment page to select different news stories. We do not suggest the users to click the links on the browser pages, because it will become very slow, anyway, Cyberus (Model No.ID801WT) is not a full function computer, it is an information machine.

Advanced functions

Gmail

You should firstly link to internet successfully before enjoy this function. please refer to the content in page 16 about network setting.

In the main menu, touch “Gmail” icon to enter the log in interface.

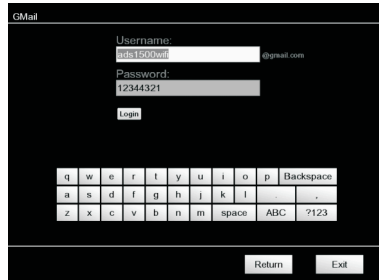

Input your user name and password by using the on-screen-keyboard, and then touch “login” icon to log in your email box. You can receive and read email only. Touch “Return” to the emails list. Touch “Exit” to the main menu.

Route

You should firstly link to internet successfully before enjoy this function. please refer to the content in page 16 about network setting.

In the main menu, touch “Route” icon to enter the interface as follow:

Input the zip code of your place and your destination by using the on-screen-keyboard, then touch “Get Directions”. The routes will be showed on the screen.

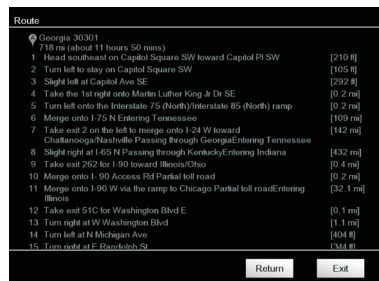
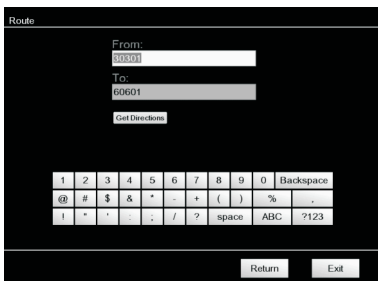

Advanced functions

Route

Attn: The route is just for reference of direction, it doesn't mean the nearest and easiest way of getting your destination.

Touch "Return" to back to last interface.

Touch "Exit" to the main menu.

Picasa

You should firstly link to internet successfully before enjoy this function. please refer to the content in page 16 about network setting.

In the main menu, touch "Picasa" icon to enter the login interface.

Input the user name and password by using the on-screen-keyboard and then touch "login" icon to check and review your pictures in Picasa folder.



Touch "Return" to the last interface.

Touch "Exit" to the main menu.

Advanced functions

Stock

You should firstly link to internet successfully before enjoy this function. please refer to the content in page 16 about network setting.

In the main menu, touch “Stock” icon to enter the interface as follow:



Input the stock symbol by using the on-screen-keyboard and then touch “Get quotes”. You will find the related stock information.

Touch “Return” to the last interface.

Touch “Exit” to the main menu.

Fast flip- Google’s online newspaper

You should firstly link to internet successfully before enjoy this function. please refer to the content in page 16 about network setting.

In the main menu, touch “Fastflip” icon to enter newspaper of four sorts: popular, topics, sections, sources. Keep touching the item that you are interested with. It will show the news content.

Use your finger or touch screen stylus to slide on the screen in straight line to move the newspaper left, right, up or down to review the whole paper.

Touch “Return” to the last interface.

Touch “Exit” to the main menu.



Screen Calibration

Screen Calibration

If the touch screen doesn't work or doesn't work correctly, you may need to adjust it through the following operation:

In the main menu, press **1** twice, then **2** twice, and then **1** twice again.

Note: Please take one second interval during each press. After 6 times press, please wait for a second and there will be a "+" appear on the upper-left screen.

Touch the very center of the "+", it will appear on upper-right, then lower right corner, then lower left corner and in the middle of the screen at last. After 5 times touch, the screen calibration will be finished and it will auto go to the main menu interface.

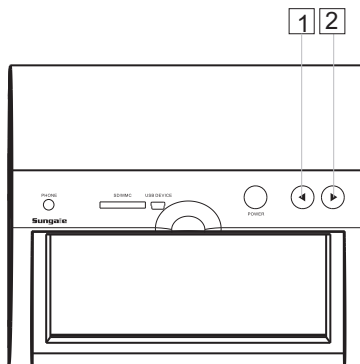

Customer management

Question & Answer

Question	Answer
How to convert on-screen -keyboard display among lower-case letters and capital letters as well as numbers?	Please refer to the content of Network in page 17.
Why player does not display picture quickly after inserting memory card?	If your picture is of high resolution, please wait for a moment. Or switch your picture by using the ASSP tool.
Which memory cards are compatible with this unit?	You can insert one of the SD/MMC cards into the Cyberus at one time.
Why picture does not cover the entire screen?	The picture whose aspect ratio is 4:3 and resolution is at or higher than 800x600 pixels may cover the entire screen.
Why won't it advance to next picture?	<ol style="list-style-type: none">1. There's only one photo in the Cyberus2. You are viewing high resolution pictures, it may take several seconds to display. You may use the ASSP tool to switch the picture if you want to display the picture quickly3. The picture is in step show mode, please touch the slide show icon to enter into slide show mode.4. The next picture has been corrupted.
Why the touch panel doesn't work correctly?	Please adjust the touch panel. You may refer to the content of screen calibration in page 24.
Why functions including weather, IP Radio, News, Youtube, Gmail, Picassa, Stock, Traffic do not work?	<ol style="list-style-type: none">1. Please make sure that you have successfully link to the internet.2. Please make sure that you have input the correct information such as Zip Code.3. Some local areas' zip code may not be in the service range.

Customer management

FCC and Safety Information

- **FCC Part 15.19**

This device complies with Part 15 of the FCC Rules .Operation is subject to the following two conditions: (1) this device may not cause harmful interference , and (2) this device must accept any interference received ,including interference that may cause undesired operation .

- **FCC part 15.21**

Warning: Changes or modifications to this unit not expressly approved by the party responsible for compliance could void the user's authority to operate the equipment.

- **FCC part 15.105**

Note : This equipment has been tested and found to comply with the limits for a Class B digital device ,pursuant to Part 15 of the FCC Rules, These limits are designed to provide reasonable protection against harmful interference in a residential installation . This equipment generates, uses, and can radiate radio frequency energy and ,if not installed and used in accordance with the instructions, may cause harmful interference will not occur in a particular installation .If this equipment does cause harmful interference to radio or television reception ,which can be determined by turning the equipment off and on ,the user is encouraged to correct the interference by one or more of the following measures:

- Reorient or relocate the receiving antenna.
- Increase the separation between the equipment and receiver.
- Connect the equipment into an outlet on circuit different form that to which the receiver is connected.
- Consult the dealer or an experienced radio TV technician for help.

LIMITED WARRANTY

The limited warranty set forth below is given by the manufacturer with respect to Sungale brand DPF players and other consumer electronics products purchased and used in the United States of America. The manufacturer warrants this product against defects in material or workmanship as follows:

LABOR: For a period of ninety (90) days from the date of purchase if this Product is defective, the manufacturer will repair or replace the Product, at its option, at no charge. After this ninety (90) days period up to one year, a labor charge of US\$30.00 will be charged for each service.

PARTS: For a period of one year from the date of purchase, the manufacturer will supply, at no charge, new or rebuilt replacement parts in exchange for defective parts. After this one year period, the manufacturer will charge the new or replacement parts.

This warranty does not cover: (1) customer instruction, installation or set up; (2) cosmetic damage or damage due to accident, misuse, abuse, or negligence; (3) commercial use of the Product; (4) modification of any part of the Product; (5) damage due to improper operation, improper maintenance, or connection to an improper voltage supply; (6) damage due to an attempted repair of the Product by anyone other than a facility authorized by the manufacturer to service the Product; (7) consumables (such as fuses and batteries). This warranty is valid only in the United States.

The product must be accompanied by a copy of the original retail purchase receipt. If no proof of purchase is attached, the warranty will not be honored and repair cost will be charged.

This warranty is valid with attach written documentation detailing the complaint to the outside or inside of the carton.

This warranty is invalid if the factory applied serial number has been altered or removed from the Product.

The manufacturer reserves the right to modify any design of this product without prior notice.

To obtain warranty service, you must deliver the product freight prepaid, in either its original packaging or packaging affording an equal degree of protection, plus proof of purchase, to:

Service Center
13941 Central Ave,
Chino, CA 91710
Tel: **800-473-5156**

REPAIR OR REPLACEMENT AS PROVIDED UNDER THIS WARRANTY IS THE EXCLUSIVE REMEDY OF THE CONSUMER. THE SERVICE CENTER SHALL NOT BE LIABLE FOR ANY INCIDENTAL OR CONSEQUENTIAL DAMAGES FOR BREACH OF ANY EXPRESS OR IMPLIED WARRANTY ON THIS PRODUCT. EXCEPT TO THE EXTENT PROHIBITED BY APPLICABLE LAW, ANY IMPLIED WARRANTY OF MERCHANTABILITY OR FITNESS FOR A PARTICULAR PURPOSE ON THIS PRODUCT IS LIMITED IN DURATION TO THE DURATION OF THIS WARRANTY.

Some states do not allow the exclusion or limitation of incidental or consequential damages, or allow limitations on how long an implied warranty lasts, so the above limitations or exclusions may not apply to you. This warranty gives you specific legal rights, and you may have other rights which vary from state to state.

Sungale